

1. 基本信息

设备编号	3125-00016
编号类型	内部编号
设备型号	M440D
建档日期	2017-10-23 08:58:22
备案有效期	2018-10-23 08:58:22
产权单位	上海市机械施工集团有限公司
采购日期	2013-05-13
产地	中国
制造商	FAVCO
臂长	55 M
最大起重量	50 T*M
起重卷扬容绳量	500 M
对地压强（地耐力参数）	kg/cm ²
总重量（约）	200 T

2. 结构反力

图1:

□

最大塔身高度 I	56
爬距范围 II	17

风速 结构反力	工作状态风速	非工作状态风速
	20	42
M		
V	750	580
MK		
H1	740	900
H2	680	670

图2:

□

风速 结构反力	工作状态风速	非工作状态风速
	20	42
M	993	1387
V	230	187
S	8	34
MK		

T	350	456
风速	工作状态风速	非工作状态风速
U	235	362
结构反力		
	20	42

图3:

□

最大塔身高度 II	
爬距范围 I	

风速	工作状态风速	非工作状态风速
结构反力		
M		
V		
MK		
H1		
H2		

3. 爬升框

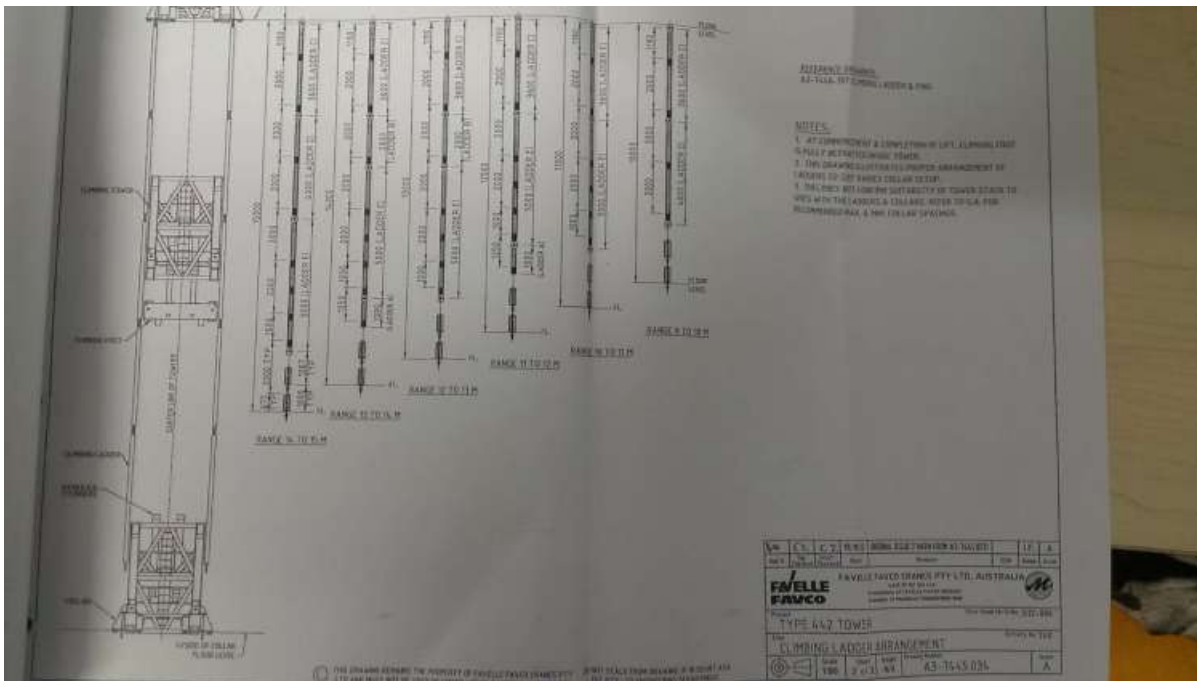
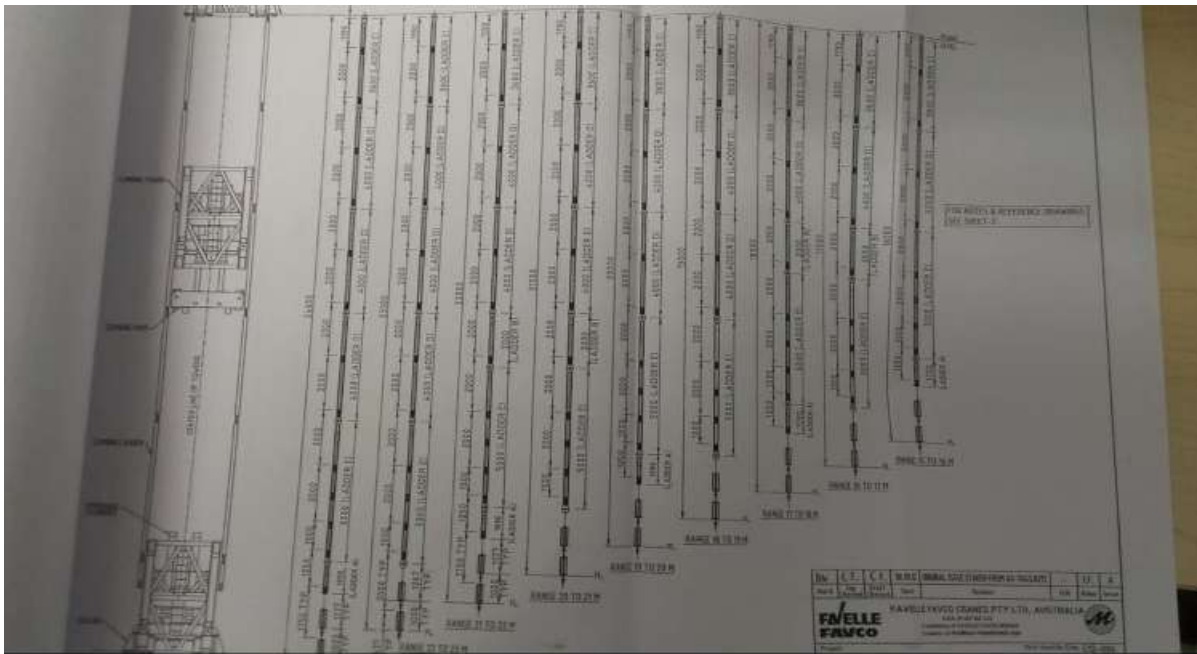

5. 外形尺寸

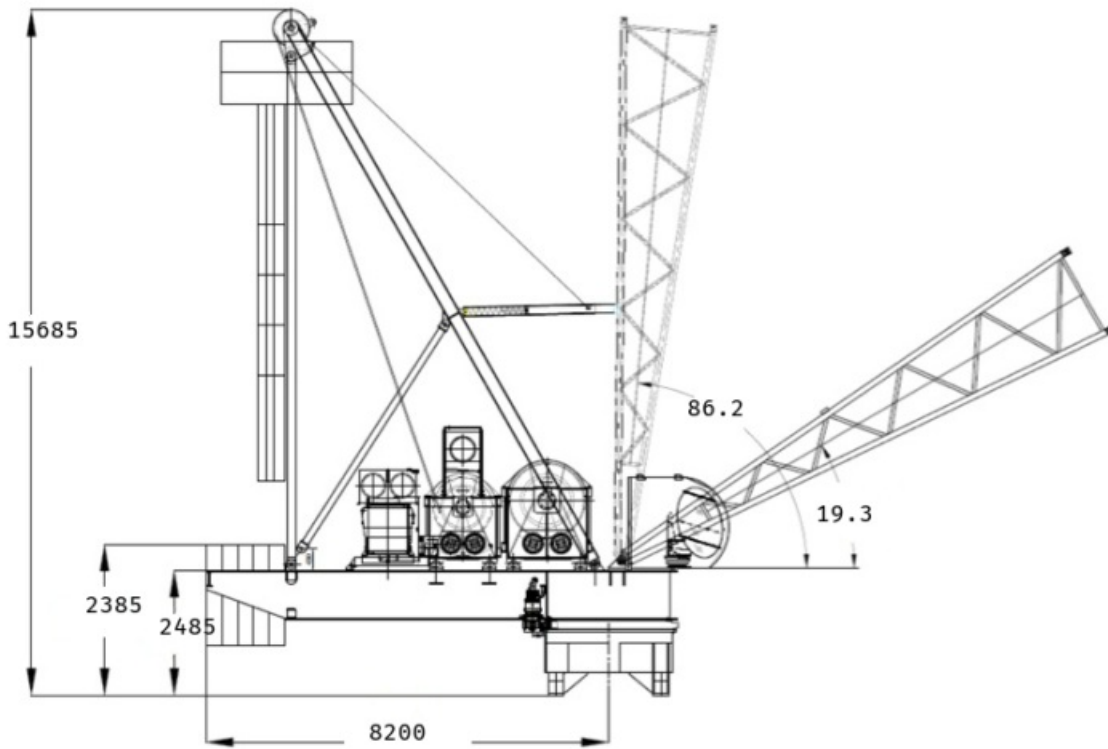

6. 设备清单

名称	数量	单重 (t)	总重 (t)	外形尺寸 (m) 长×宽×高	备注
一、主机部分					
机械平台 (前部)	1	6.83	6.83	3.6×3.4×2.2	
机械平台 (后部)	1	7.92	7.92	6.5×3.4×1.5	
人字架总成	1	6.3	6.3	7.4×4.1×12.5	
驾驶舱总成	1	1.3	1.3	2.1×1.7×2.5	
动力包	1	22	22	4.25×2.8×2.23	含主卷和变幅系统
下回转	1	9.4	9.4	4.1×4.1×1.9	含回转齿圈
二、塔节部分					
内顶升节总成	1	12.5	12.5	2.721×2.709×4.78	含两个油缸和大梁
标准节	11	4.9	53.9	2.721×2.709×4	
顶升套架	3	5.2	15.6	7.97×0.21×0.21	爬升框
加强节	2	7	14	4×2.7×2.7	
爬带	1	5	5	××	
三、塔臂部分					
伸臂根节	1	2.4	2.4	13.7×3.1×2.3	
伸臂延长节_1	3	1.6	4.8	9.3×2.3×2.3	

伸臂顶节 名称	数量	单重 (t)	总重 (t)	外形尺寸 (mm) ³ 长×宽×高	备注
四、吊索件					
主吊钩	1	1.4	1.4	1.2×0.3×2.5	50t
变幅滑轮组	1	1.2	1.2	××	
临时拉索	1	1	1	××	55
五、配重					
配重块	10	4	40	××	
			总重量	208.75 吨	

7. 载荷性能曲线及起重性能表

LOAD CHART 30.0m RADIUS BOOM						
RADIUS (M)	3.0	13.3	15.0	20.0	25.0	30.0
LOAD (T)	50.0	50.0	43.5	31.3	24.2	19.5
ANGLE	66.0	66.9	65.5	52.9	40.5	23.3

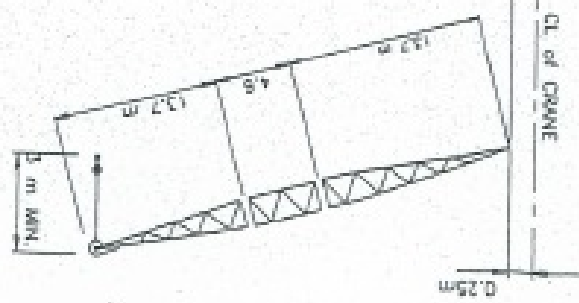
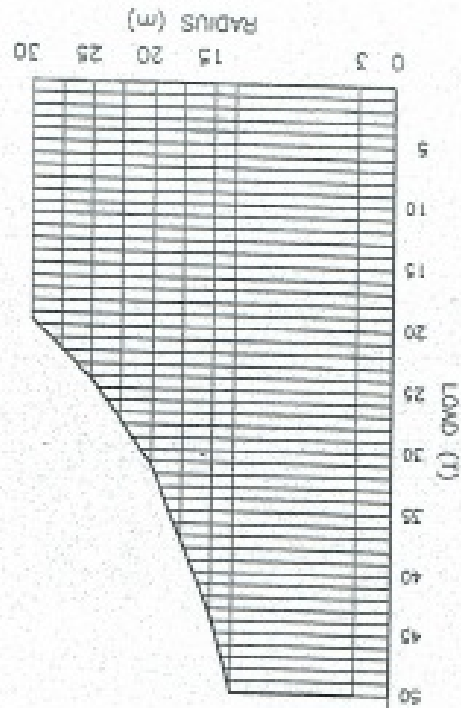

LOAD CHART M440D
30.0m RADIUS BOOM



LOAD CHART 35.0m RADIUS BOOM		RADIUS (M)		LOAD (T)		ANGLE	
3.3	13.3	15.0	20.0	25.0	30.0	35.0	
50.0	50.0	43.3	30.8	24.0	19.4	16.1	
86.0	69.5	67.1	58.2	48.4	36.7	20.0	

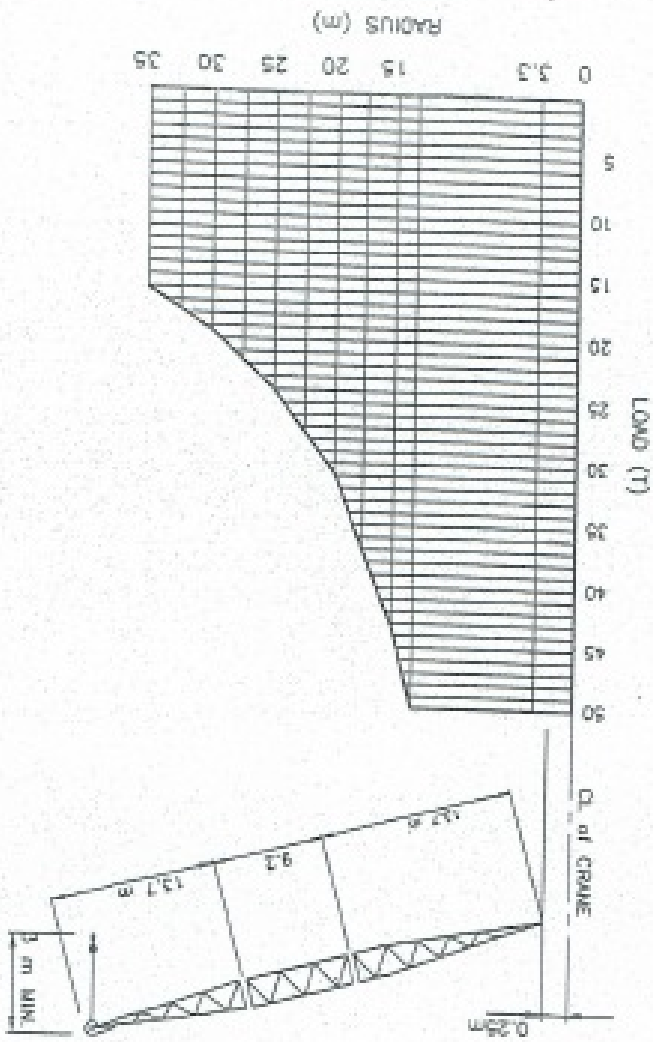

LOAD CHART M440D
35.0m RADIUS BOOM



LOAD CHART 40.0m RADIUS BOOM	
RADIUS (m)	3.7 13.2 15.0 20.0 25.0 30.0 35.0 40.0
LOAD (T)	50.0 50.0 42.8 30.7 23.8 19.0 15.6 13.1
ANGLE	85.9 72.4 70.0 62.1 53.8 44.7 33.5 18.9

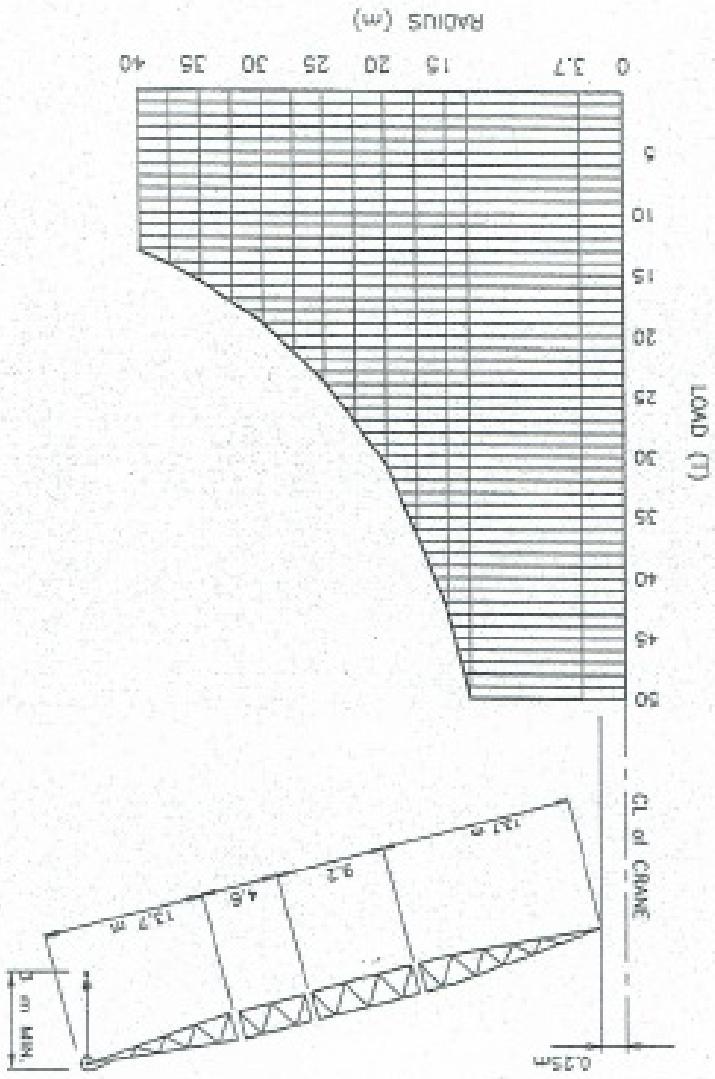

LOAD CHART M440D
40.0m RADIUS BOOM



LOAD CHART 42.5m RADIUS BOOM									
RADIUS (M)		LOAD (T)		ANGLE					
3.9	13.0	15.0	20.0	25.0	30.0	35.0	40.0	42.5	
50.0	50.0	42.3	30.8	23.5	18.7	15.4	12.8	11.7	
86.1	74.5	71.9	65.1	58.0	50.2	41.5	30.8	23.9	

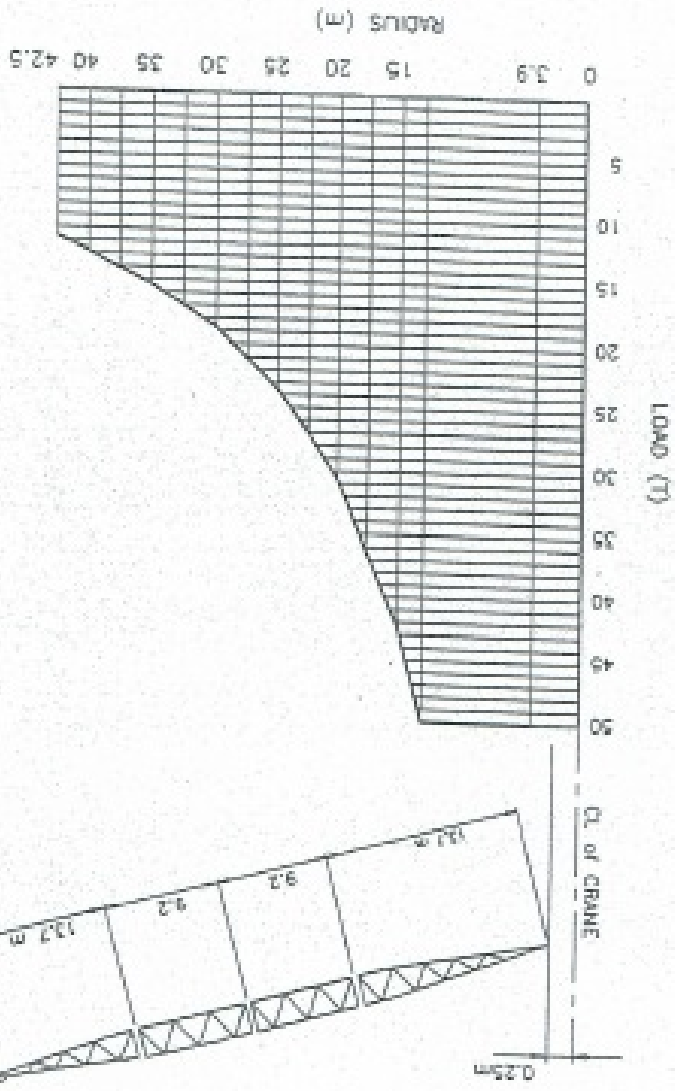

LOAD CHART M440D
42.5m RADIUS BOOM



LOAD CHART 47.5m RADIUS BOOM				
RADIUS (M)	LOAD (T)	ANGLE		
4.2	50.0	86.1	77.1	73.8
12.0	50.0	82.0	73.8	67.8
15.0	42.0	80.2	73.0	61.2
20.0	30.0	75.0	64.5	54.5
25.0	23.0	68.3	57.1	47.1
30.0	18.0	60.7	49.7	39.7
35.0	14.0	52.3	42.4	32.3
40.0	10.0	43.1	35.1	25.1
45.0	7.5	34.1	28.1	18.1
47.5	6.5	31.5	26.5	16.5

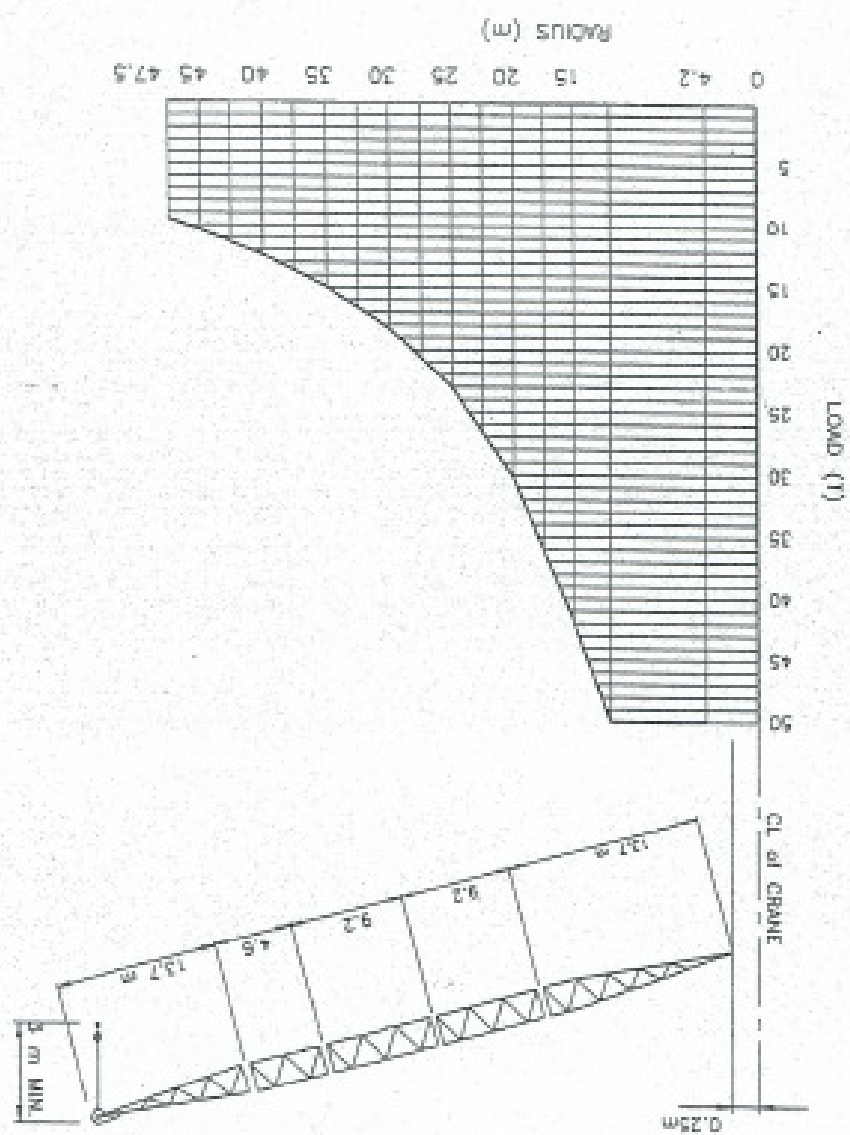

LOAD CHART M4400
47.5m RADIUS BOOM



LOAD CHART 52.5m RADIUS BOOM											
RADIUS (M)	4.4	14.0	15.0	20.0	25.0	30.0	35.0	40.0	45.0	50.0	52.5
LOAD (T)	44.0	44.0	41.0	29.8	22.8	18.1	14.6	12.0	10.0	8.5	8.0
ANGLE	86.2	76.1	75.0	69.5	63.8	57.9	51.4	44.4	36.3	28.1	19.3

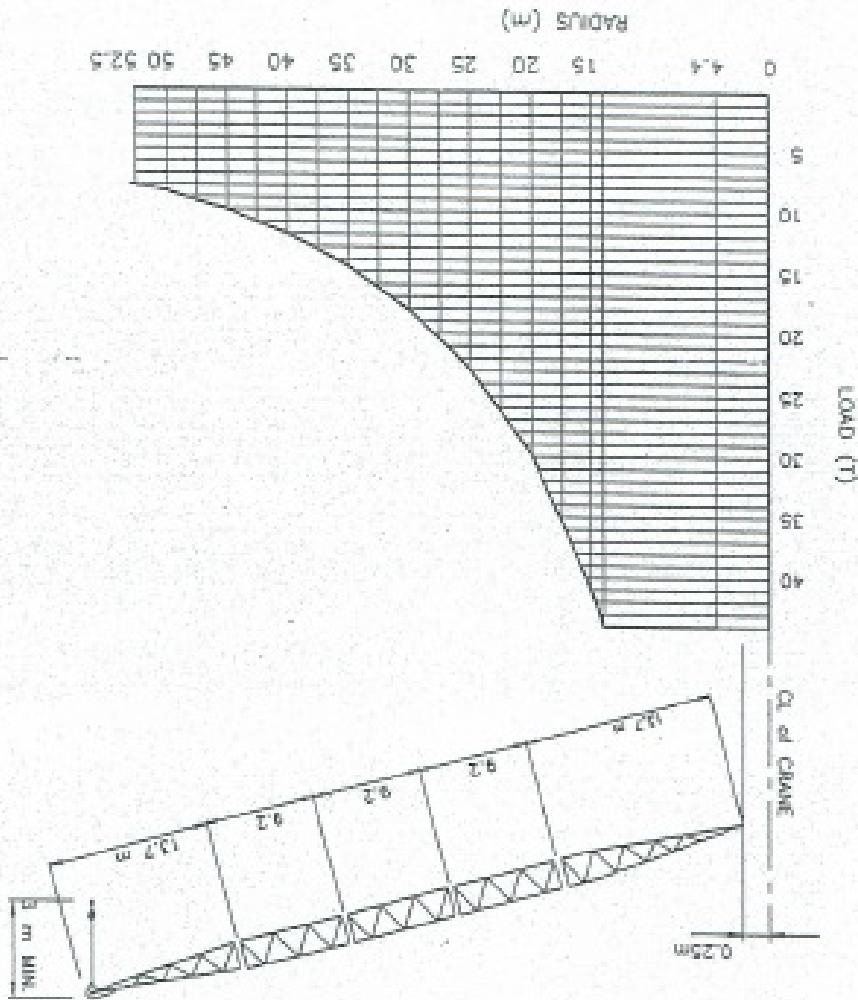

LOAD CHART M440D
52.5m RADIUS BOOM



LOAD CHART 60.0m RADIUS BOOM													
RADIUS (M)	5.3	8.6	10.0	15.0	20.0	25.0	30.0	35.0	40.0	45.0	50.0	55.0	60.0
LOAD (T)	32.0	32.0	30.6	26.3	23.0	20.0	16.8	13.6	11.2	9.3	7.6	6.3	4.8
ANGLE	88.0	83.0	81.7	77.2	72.6	67.8	62.8	57.7	52.3	46.4	39.8	32.2	22.3

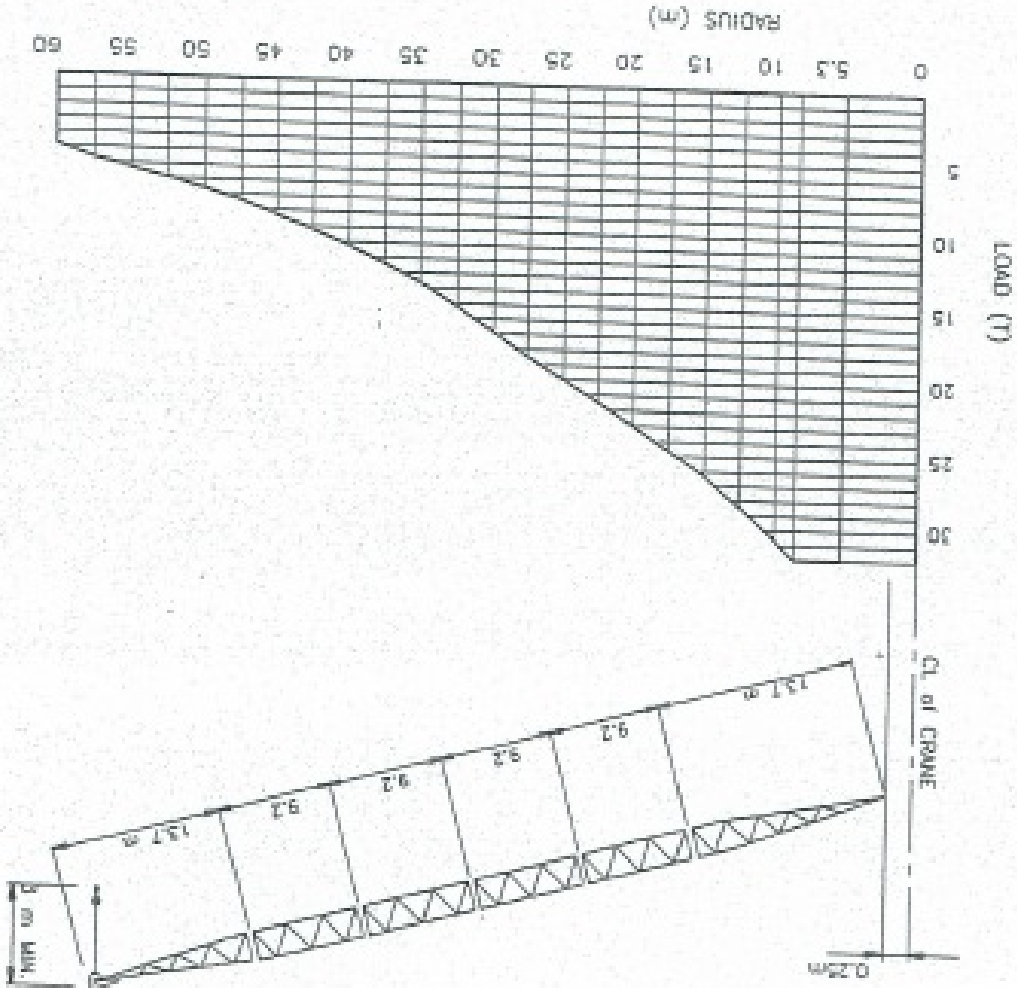

LOAD CHART M440D
60.0m RADIUS BOOM

440-65-101A

LOAD CHART 65.0m RADIUS BOOM										
RADIUS (m)	LOAD (T)	ANGLE								
6.0	11.8	85.6	80.8	78.0	73.7	69.3	64.8	60.1	55.2	49.9
11.8	13.0	85.0	78.5	75.0	70.0	65.0	60.0	55.0	50.0	44.2
19.0	15.0	82.5	75.0	70.0	64.0	58.0	53.0	48.0	43.0	37.8
25.0	17.2	80.8	72.5	67.0	61.0	55.0	50.0	45.0	40.0	35.0
30.0	19.5	78.0	70.0	64.0	58.0	53.0	48.0	43.0	38.0	33.0
35.0	22.5	73.7	67.0	61.0	55.0	50.0	45.0	40.0	35.0	30.6
40.0	25.0	69.3	64.0	58.0	53.0	48.0	43.0	38.0	33.0	28.8
45.0	27.2	64.8	60.0	55.0	50.0	45.0	40.0	35.0	30.0	25.8
50.0	29.5	60.1	55.0	50.0	45.0	40.0	35.0	30.0	25.0	20.8
55.0	31.8	55.2	50.0	45.0	40.0	35.0	30.0	25.0	20.0	15.8
60.0	34.2	49.9	45.0	40.0	35.0	30.0	25.0	20.0	15.0	10.8
65.0	36.8	44.2	40.0	35.0	30.0	25.0	20.0	15.0	10.0	5.8

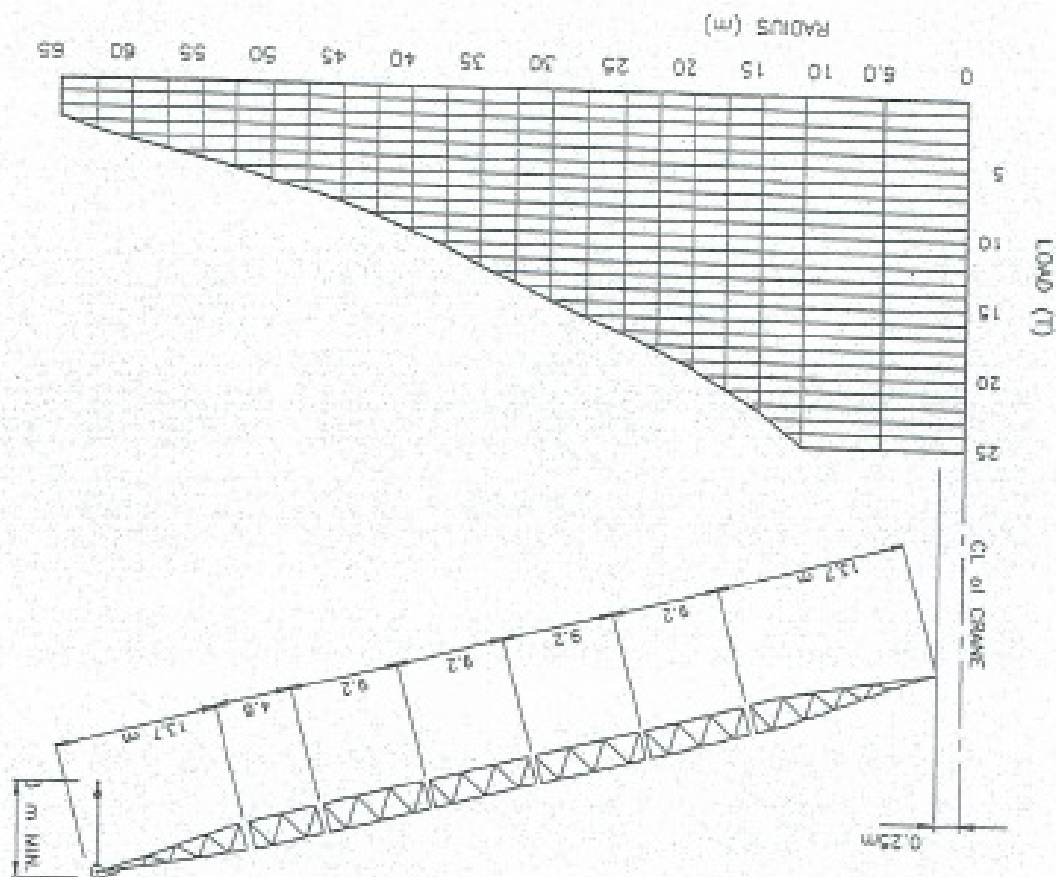

LOAD CHART M440D
65.0m RADIUS BOOM



8. 其他证照资料

制造许可证:

3125-15#

CERTIFICATE OF MANUFACTURE

FAVELLE FAVCO

LOT 42, PERSTARAN BUNGA TANJUNG 2,
SENAWANG INDUSTRIAL PARK,
70400 SEREMBAN,
NEGERI SEMBILAN DARUL KHUSUS, MALAYSIA.
TEL : (606) 6768866
FAX : (606) 6768888
E-MAIL : admin@favellefavco.com.my

制造证书

Certificate No : FFCM/12- 1863-M

CUSTOMER : FAVCO INTERNATIONAL (SHANGHAI) Co. LTD
SUITE E, 17 FLOOR, JINMING BUILDING,
NO. 8, ZUN YI NAN ROAD, CHANG NING QU.
SHANGHAI, 200336, P.R CHINA

客户: 上海法福克起重工程设备有限公司

Description : 描述

CRANE MODEL : M440D

塔机型号: M440D

S/N : 1863

序列号: 1863

QUANTITY : 1 UNIT

数量: 件

MANUFACTURER : FAVELLE FAVCO CRANES

制造商: 法福克起重机制造公司

THE ABOVE CRANE WAS DESIGNED AND MANUFACTURED BY

FAVELLE FAVCO CRANES IN 2012 TO CONFORM TO AUSTRALIAN

STANDARD AS1418, PART 1 & 4

上述塔机由法福克起重机制造公司在2012年
设计和制造符合澳洲制造标准AS 1418第1和
第4章

Signed : 
MR LIM YUI KHONG
QA/QC MANAGER

Date : 19-DEC-2012

For and on behalf of : FAVELLE FAVCO CRANES (M) SDN. BHD.

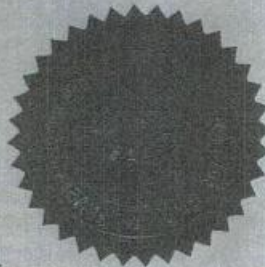

3125-15#



LOT 42, PERSIARAN BUNGA TANJUNG 2,
SENAWANG INDUSTRIAL PARK,
70400 SEREMBAN,
NEGERI SEMBILAN DARUL KHUSUS, MALAYSIA.
TEL : (606) 6768866
FAX : (606) 6768888
E-MAIL : admin@favellefavco.com.my

Ref No : FFCM/1863/2012

Project	项目	Crane Model	型号	Crane Serial No	序列号	Date	日期
TOWER CRANE	塔式起重机	M440D	M440D	1863	1863	19-DEC-2012	19-12-12

CERTIFICATE OF QUANTITY & QUALITY 数量&质量证明

CUSTOMER : FAVCO INTERNATIONAL SHANGHAI
 客户: 上海法福克起重工程设备有限公司
COUNTRY OF ORIGIN : MALAYSIA
 原产地: 马来西亚
GOODS DESCRIPTION : TOWER CRANE 货物描述: 塔式起重机
MANUFACTURER : FAVELLE FAVCO CRANES (M) SDN BHD
 制造商: 法福克起重机制造公司
YEAR OF MANUFACTURE : 2012
 制造年份: 2012

WE CERTIFIED THAT THE COMPONENT WERE DESIGNED AND MANUFACTURED ON THE DATE STATED AND CONFIRMED ALL THE REQUIREMENT OF THE CONTRACT or PURCHASE ORDER.
 CRANE STRUCTURE WERE DESIGNED TO AS 1418 PART 1 & 4
 THE COMPONENT LISTED BELOW HAD BEEN INSPECTED SATISFACTORY AND DELIVERED TO ABOVE ADDRESS.

QUANTITY /WEIGHT OF SHIPPED GOODS : 我们证明组件均在所陈述的日期里设计和制造完成, 符合合同及订单里的所有要求。吊车结构按AS 1418制造标准的第1章节和第4章节设计, 经检验合格递交上述地址, 所有组件明细如下。

Package	QTY	DESCRIPTION	GROSS WT (T)
包裹	数量	描述	毛重 (吨)
1	1	Machinery deck assembly (including slew ring & dri	89 89吨
2	1	Slew ring and drive assembly 机械平台总成 (包括回转盘&驱动总成)	2.9 2.9吨
3	1	Slew mount assembly & platform 回转盘和驱动总成	6.6 6.6吨
4	1	Hoist / Luff winch assembly 主提升/变幅绞机总成	11 11吨
5	1	Hoist rope 主卷钢丝绳	4.4 4.4吨
6	1	Luff rope 变幅钢丝绳	0.8 0.8吨
7	1	Cabin assembly 驾驶室总成	0.7 0.7吨
8	1	Platforms, ladders & handrails 工作台, 扶梯和栏杆	1.65 1.65吨
9	1	Counterweight assembly 配重块总成	40 40吨
10	1	Miscellaneous Items 其他杂项	1.5 1.5吨
11	1	powerpack 动力包	4.4 4.4吨
12	1	Mast assembly A架总成	6.3 6.3吨
13	1	Boom assembly 大臂总成	11 11吨
14	1	Bridle assembly 索具总成	0.6 0.6吨
15	1	Hook block 吊钩滑车	1.3 1.3吨
16	1	Pendant rope 拉索	0.96 0.96吨

SIGNATURE

Date : 19-DEC-2012

For and on behalf of FAVELLE FAVCO CRANES (M) SDN. BHD

备案证书或IC卡:

上海市建筑起重机械产权备案登记证

设备信息栏

编号：沪-T-11122

设备名称：塔式起重机

产权单位：上海市机械施工集团有限公司

型号规格：M440D

单位地址：上海市嘉定区顺达路615号

制造单位：Favelle Favco Cranes (M)SDN BHD

出厂编号：1871

登记机关：上海市建设安全协会

出厂日期：2013年05月13日

上海市建筑起重机械
(盖章)
产权备案登记专用章
2018年12月16日

特种设备生产许可证编号：

2C-0020.3

登记证编号：T004993