

1. 基本信息

设备编号	3125-00017
编号类型	内部编号
设备型号	M440D
建档日期	2017-10-17 13:20:26
备案有效期	2018-10-17 13:20:26
产权单位	上海市机械施工集团有限公司
采购日期	2016-04-07
产地	中国
制造商	FAVCO
臂长	55 M
最大起重量	50 T*M
起重卷扬容绳量	500 M
对地压强（地耐力参数）	kg/cm ²
总重量（约）	200 T

2. 结构反力

图1:

□

最大塔身高度 I	56
爬距范围 II	17

风速 结构反力	工作状态风速	非工作状态风速
	20	42
M		
V	750	580
MK		
H1	740	900
H2	680	670

图2:

□

风速 结构反力	工作状态风速	非工作状态风速
	20	42
M	993	1387
V	230	187
S	8	34
MK		

T	350	456
风速	工作状态风速	非工作状态风速
U	235	362
结构反力		
	20	42

图3:

□

最大塔身高度 II	
爬距范围 I	

风速	工作状态风速	非工作状态风速
结构反力		
M		
V		
MK		
H1		
H2		

3. 爬升框

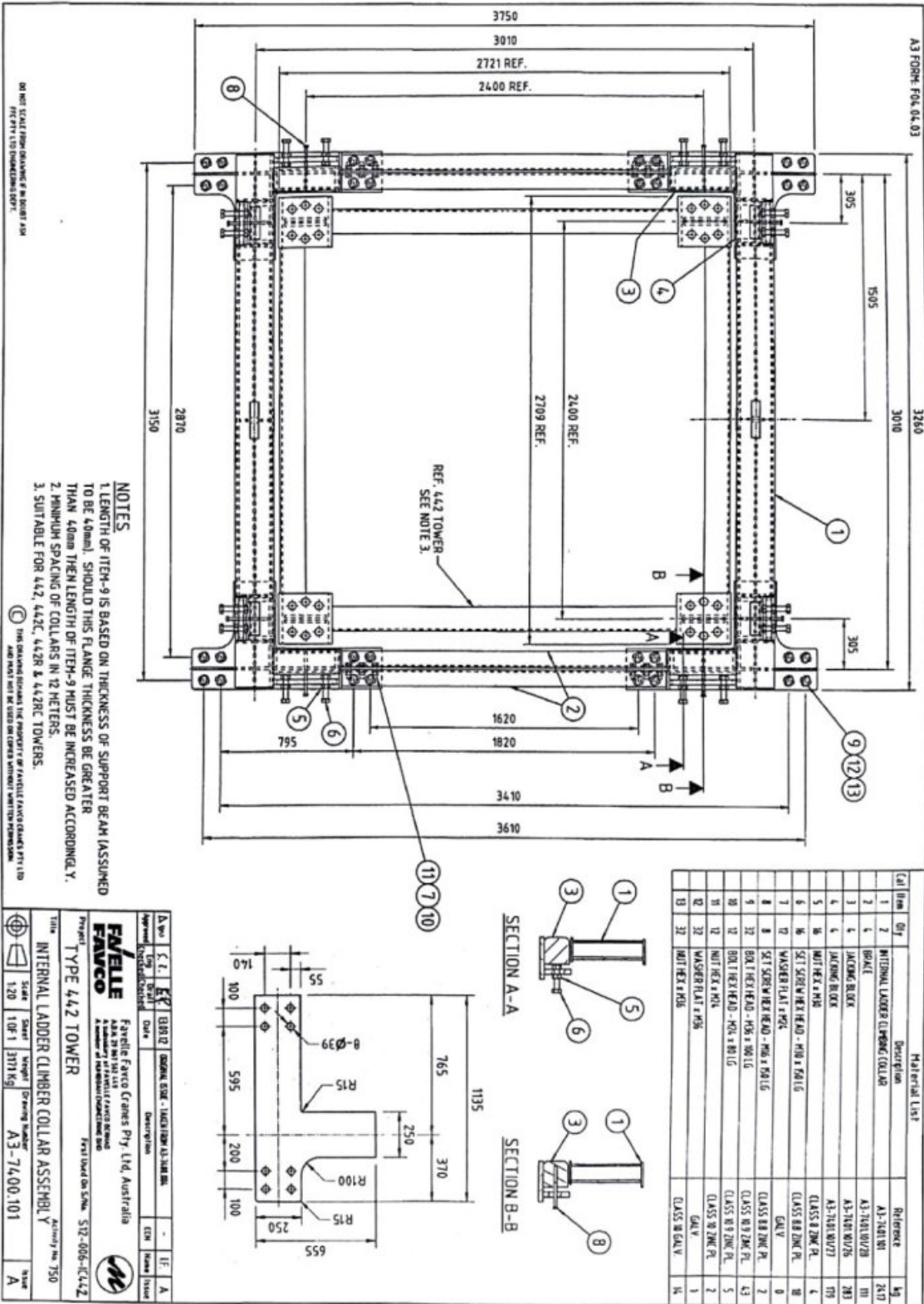

4. 爬帶配置

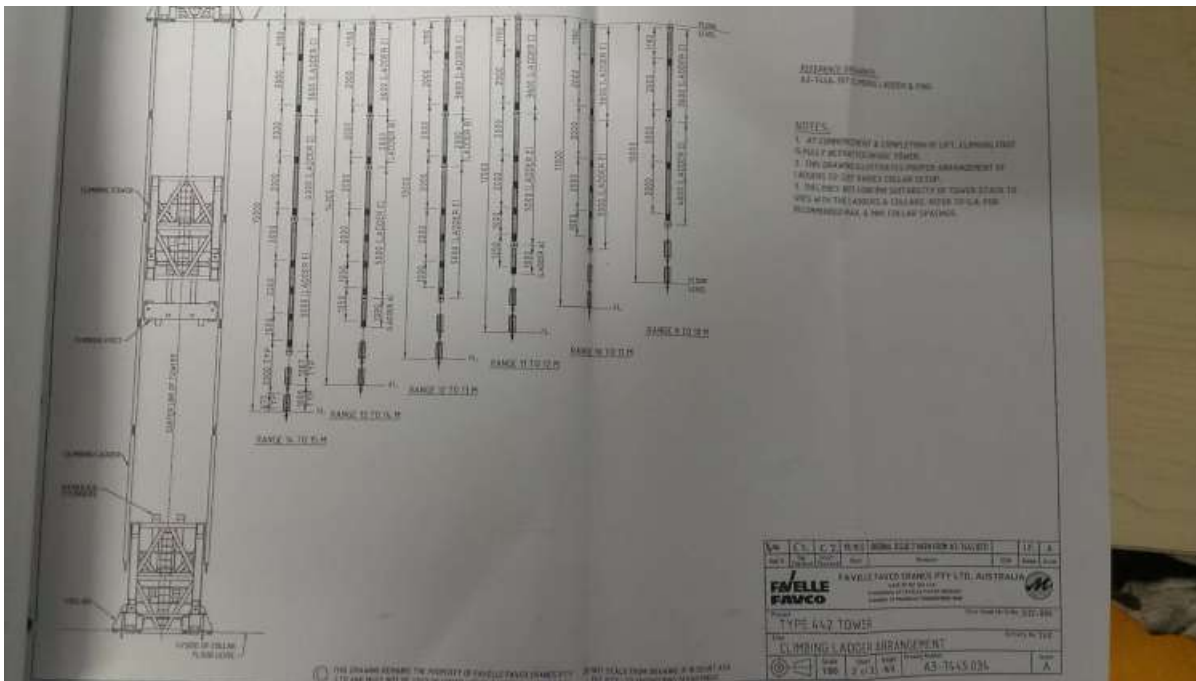
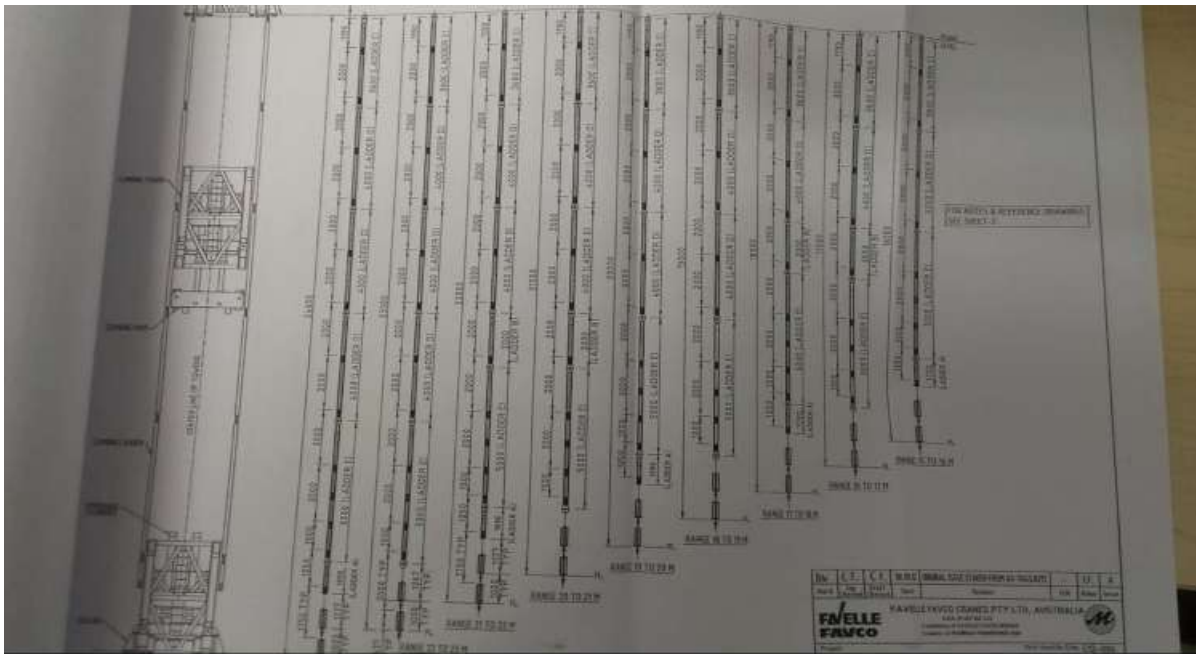

5. 外形尺寸

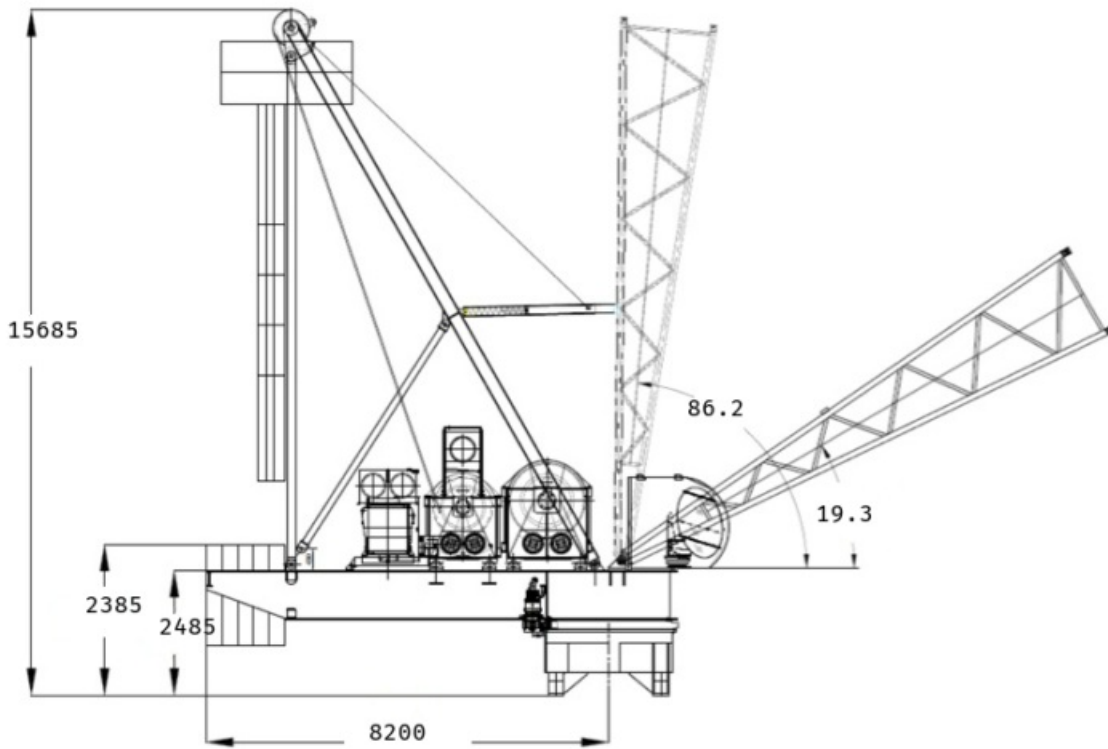

6. 设备清单

名称	数量	单重 (t)	总重 (t)	外形尺寸 (m) 长×宽×高	备注
一、主机部分					
机械平台 (前部)	1	6.83	6.83	3.6×3.4×2	
机械平台 (后部)	1	7.92	7.92	6.6×3.7×1.5	
人字架总成	1	6.3	6.3	13.85×3.4×1.76	
驾驶室总成	1	1.3	1.3	2.1×1.7×2.5	
动力包	1	22	22	6.1×2.9×3	含主卷和变幅系统
下回转	1	9.4	9.4	4.2×4.2×2.1	含回转齿圈
二、塔节部分					
内顶升节总成	1	12.5	12.5	2.721×2.709×4.78	含两个油缸和大梁
标准节	11	4.9	53.9	2.721×2.709×4	
顶升套架	3	5.2	15.6	3.51×0.935×1.2	爬升框
加强节	2	7	14	4×2.72×2.7	
爬带	1	5	5	××	
三、塔臂部分					
伸臂根节	1	2.4	2.4	13.7×3.1×2.3	
伸臂延长节_1	3	1.6	4.8	9.3×2.3×2.3	

伸臂顶节 名称	数量	单重 (t)	总重 (t)	外形尺寸 (mm) ³ 长×宽×高	备注
四、吊索件					
主吊钩	1	1.4	1.4	1.2×0.3×2.5	50t
变幅滑轮组	1	1.2	1.2	××	
临时拉索	1	1	1	××	55
五、配重					
配重块	4	10	40	3.1×0.1×2.31	
			总重量	208.75 吨	

7. 载荷性能曲线及起重性能表

LOAD CHART 30.0m RADIUS BOOM				
RADIUS (M)	LOAD (T)	LOAD (T)	ANGLE	
3.0	13.3	15.0	20.0	25.0
5.0	13.3	15.0	20.0	25.0
10.0	13.3	15.0	20.0	25.0
15.0	13.3	15.0	20.0	25.0
20.0	13.3	15.0	20.0	25.0
25.0	13.3	15.0	20.0	25.0
30.0	13.3	15.0	20.0	25.0

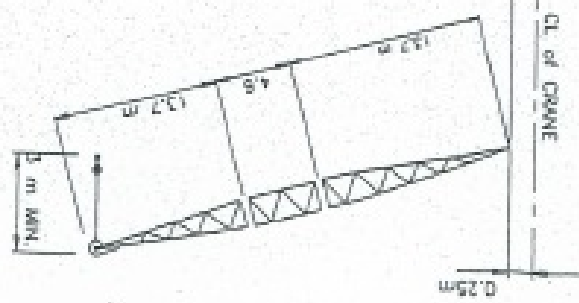
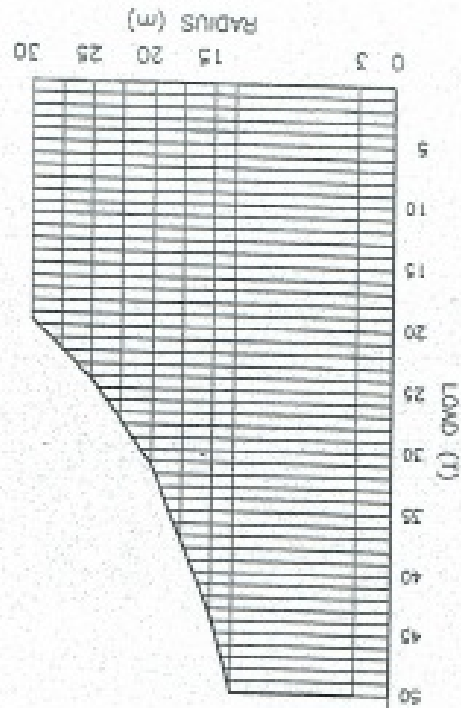

LOAD CHART M440D
30.0m RADIUS BOOM



LOAD CHART 35.0m RADIUS BOOM		RADIUS (M)		LOAD (T)		ANGLE	
3.3	13.3	15.0	20.0	25.0	30.0	35.0	
50.0	50.0	43.3	30.8	24.0	19.4	16.1	
86.0	69.5	67.1	58.2	48.4	36.7	20.0	

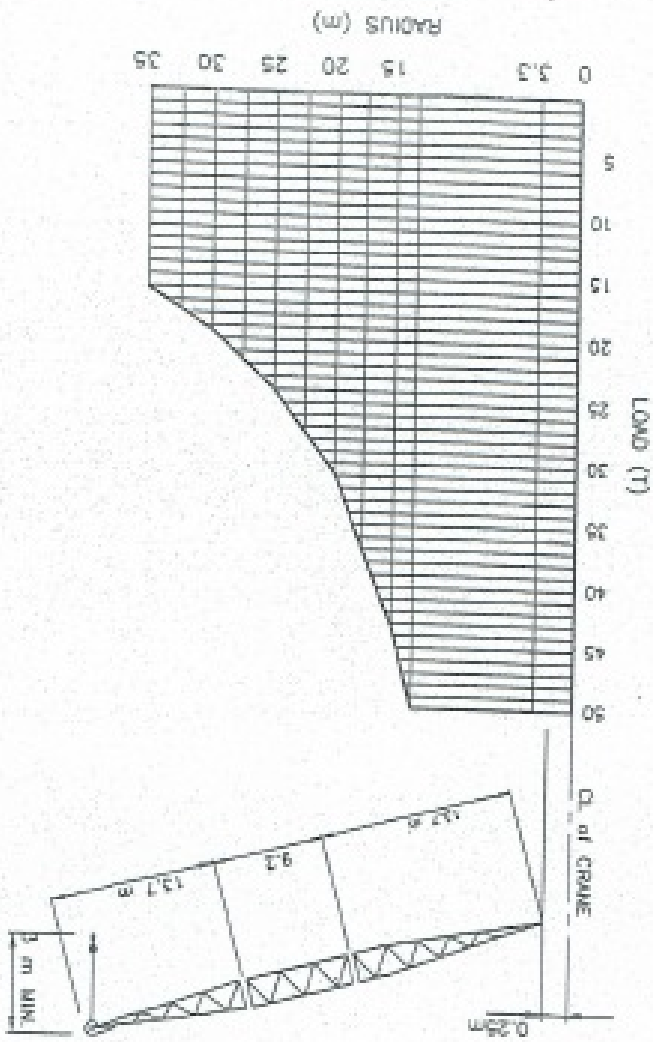

LOAD CHART M440D
35.0m RADIUS BOOM



LOAD CHART 40.0m RADIUS BOOM	
RADIUS (m)	3.7 13.2 15.0 20.0 25.0 30.0 35.0 40.0
LOAD (T)	50.0 50.0 42.8 30.7 23.8 19.0 15.6 13.1
ANGLE	85.9 72.4 70.0 62.1 53.8 44.7 33.5 18.9

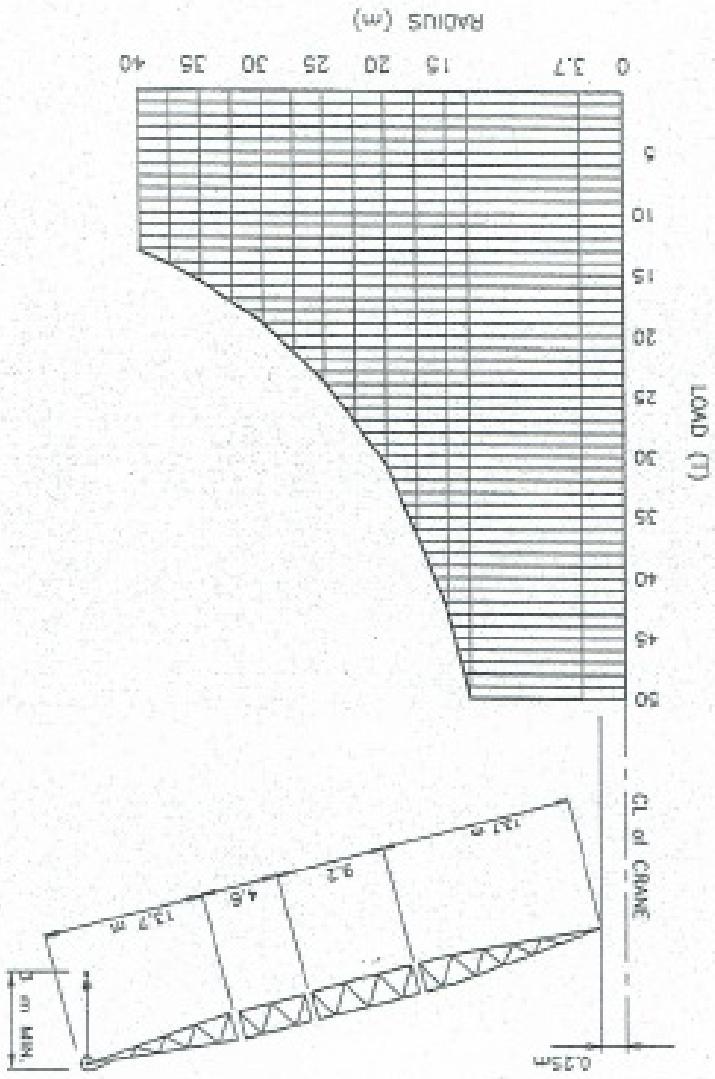

LOAD CHART M440D
40.0m RADIUS BOOM



LOAD CHART 42.5m RADIUS BOOM									
RADIUS (M)		LOAD (T)		ANGLE					
3.9	13.0	15.0	20.0	25.0	30.0	35.0	40.0	42.5	
50.0	50.0	42.3	30.8	23.5	18.7	15.4	12.8	11.7	
86.1	74.5	71.9	65.1	58.0	50.2	41.5	30.8	23.9	

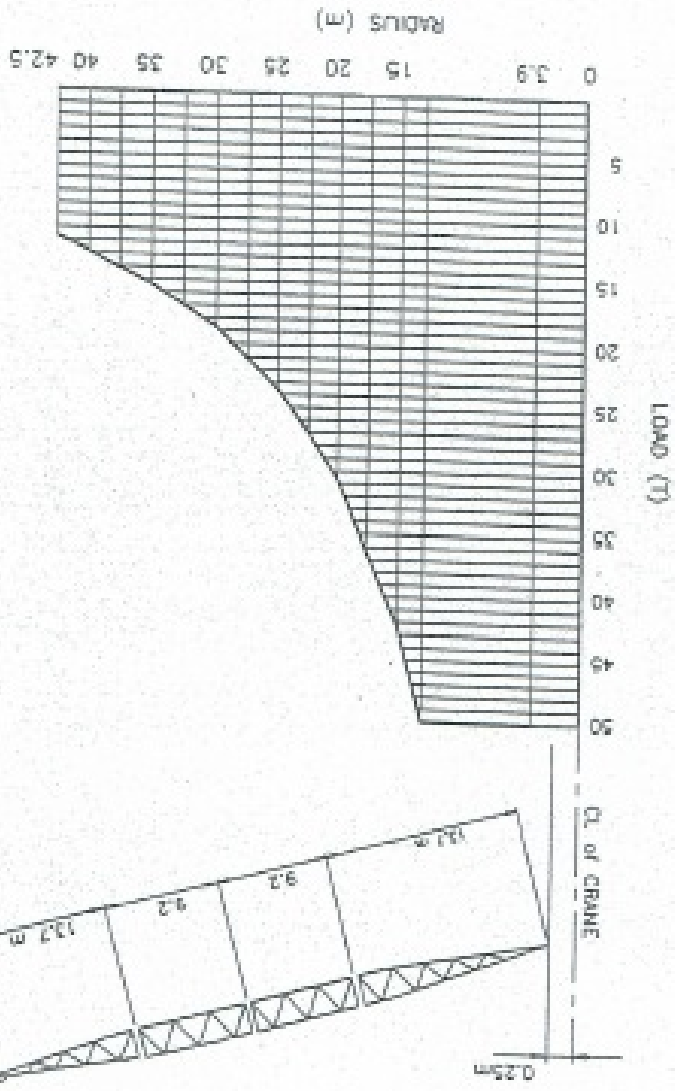

LOAD CHART M440D
42.5m RADIUS BOOM



LOAD CHART 47.5m RADIUS BOOM					
RADIUS (M)	LOAD (T)	ANGLE			
4.2	50.0	86.1	77.1	73.8	67.8
12.0	50.0	82.0	70.2	67.0	61.2
15.0	42.0	73.8	67.8	61.2	54.5
20.0	30.2	61.2	54.5	47.1	38.7
25.0	23.0	47.1	38.7	28.3	21.5
30.0	18.3				
35.0	14.9				
40.0	12.4				
45.0	10.4				
47.5	9.5				

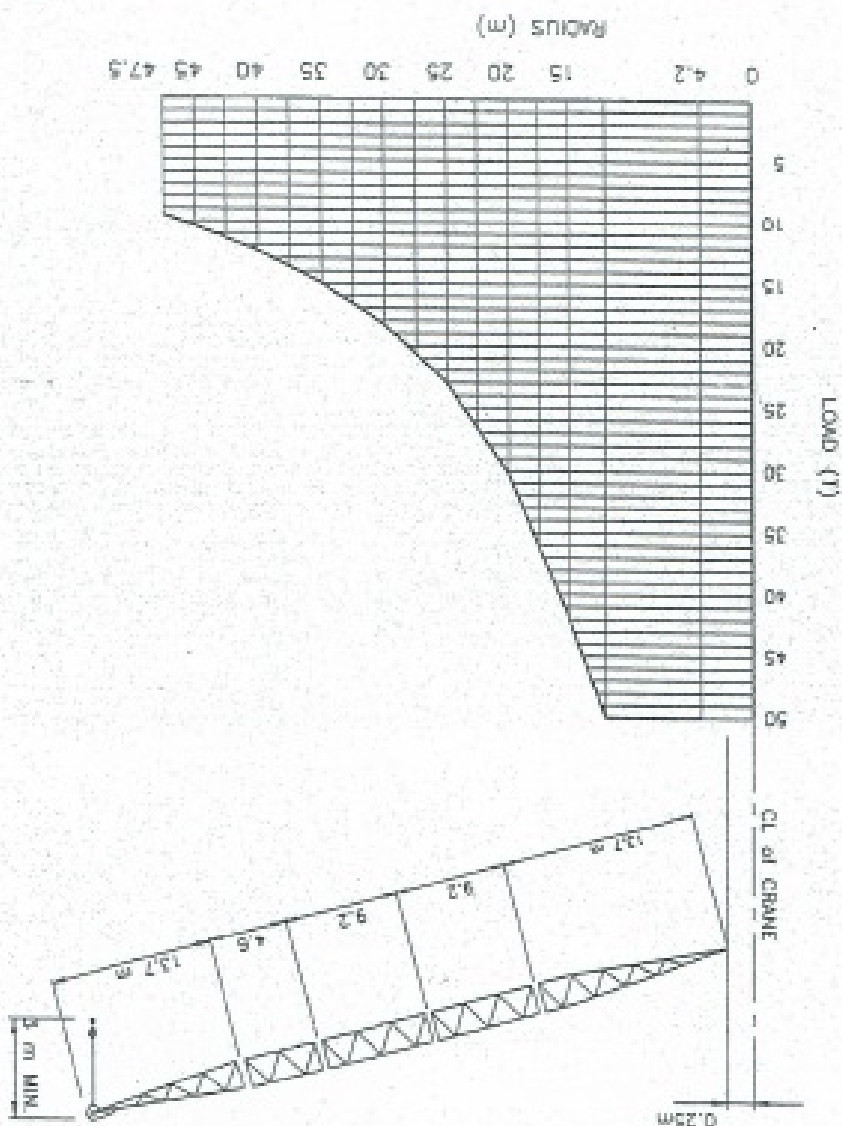

LOAD CHART M4400
47.5m RADIUS BOOM



LOAD CHART 52.5m RADIUS BOOM											
RADIUS (M)	4.4	14.0	15.0	20.0	25.0	30.0	35.0	40.0	45.0	50.0	52.5
LOAD (T)	44.0	44.0	41.0	29.8	22.8	18.1	14.6	12.0	10.0	8.5	8.0
ANGLE	86.2	76.1	75.0	69.5	63.8	57.9	51.4	44.4	36.3	28.1	19.3

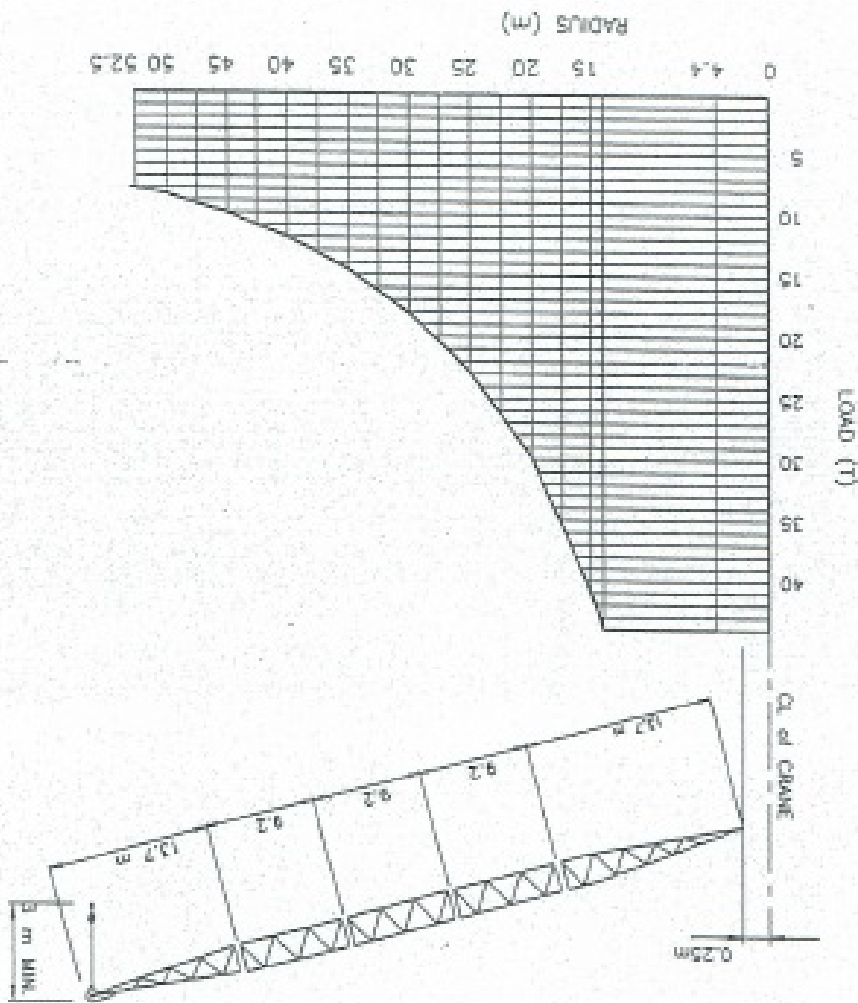

LOAD CHART M440D
52.5m RADIUS BOOM



LOAD CHART 60.0m RADIUS BOOM													
RADIUS (M)	5.3	8.6	10.0	15.0	20.0	25.0	30.0	35.0	40.0	45.0	50.0	55.0	60.0
LOAD (T)	32.0	32.0	30.6	28.3	23.0	20.0	16.8	13.6	11.2	9.3	7.6	6.3	4.8
ANGLE	88.0	83.0	81.7	77.2	72.6	67.8	62.8	57.7	52.3	46.4	39.8	32.2	22.3

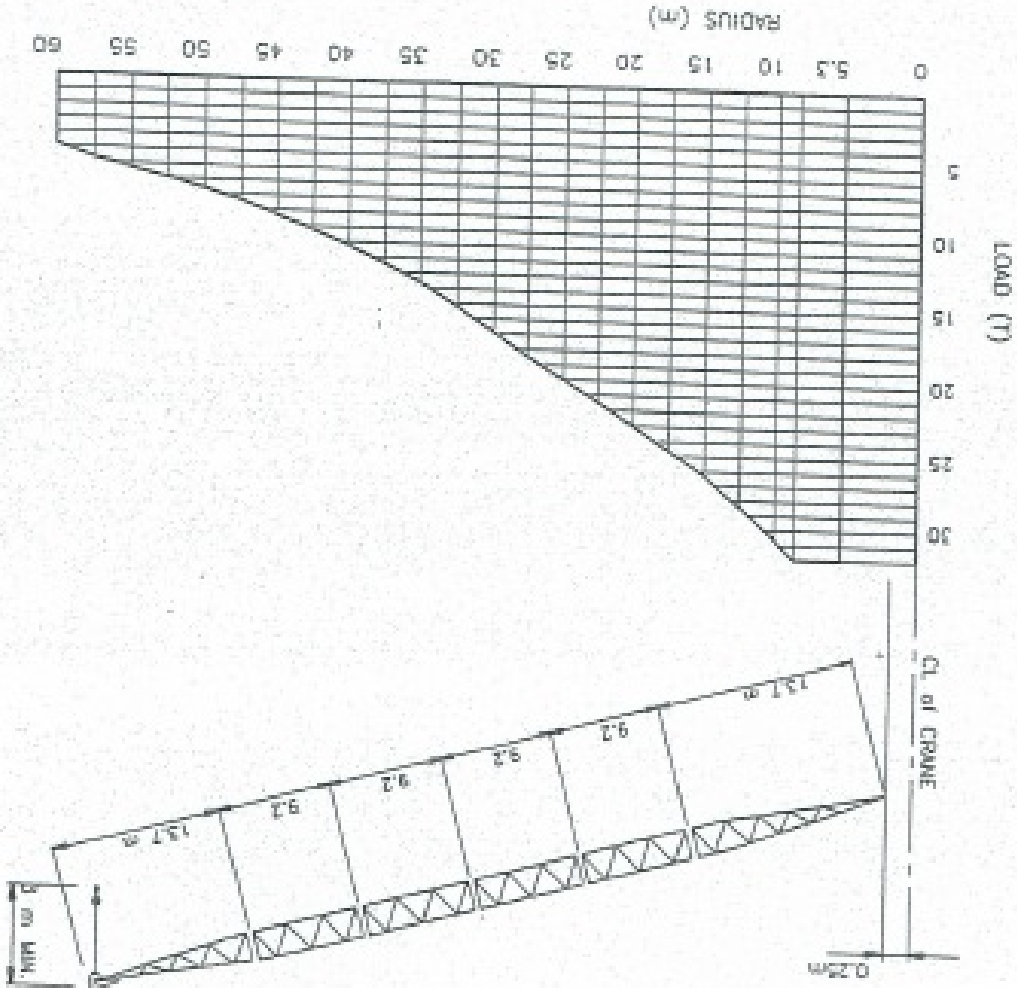

LOAD CHART M440D
60.0m RADIUS BOOM



440-65-101A

LOAD CHART 65.0m RADIUS BOOM										
RADIUS (m)	6.0	11.8	15.0	20.0	25.0	30.0	35.0	40.0	45.0	50.0
LOAD (T)	25.0	25.0	22.5	19.5	17.2	15.0	12.6	10.2	8.3	6.9
ANGLE	85.6	80.8	78.0	73.7	69.3	64.8	60.1	55.2	49.9	44.2
	20.6	30.6	4.3	2.7						

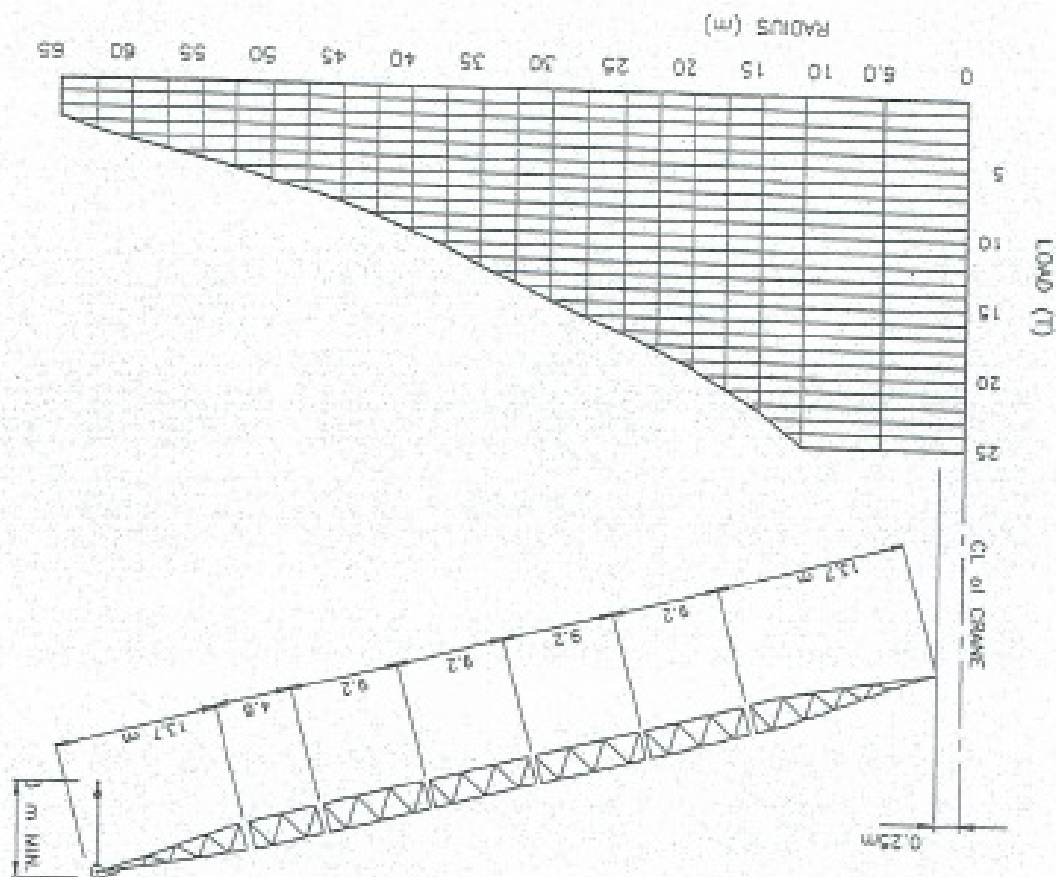

LOAD CHART M440D
65.0m RADIUS BOOM



8. 其他证照资料

制造许可证:

3125-17*

CERTIFICATE OF MANUFACTURE



LOT 42, PERSIARAN BUNGA TANJUNG 2,
SENAWANG INDUSTRIAL PARK,
70400 SEREMBAN,
NEGERI SEMBILAN DARUL KHUSUS, MALAYSIA.
TEL : (606) 6768866
FAX : (606) 6768888
E-MAIL : admin@favellefavco.com.my

Certificate No : FFCM/16-2230-M

CLIENT : FAVCO INTERNATIONAL (SHANGHAI) CO. LTD
SUITE E, 17 FLOOR, JINMING BUILDING,
NO. 8, ZUN YI NAN ROAD, CHANG NING QU.
SHANGHAI, 200336, P.R CHINA

Description :

CRANE MODEL : M440D

S/N : 2230

QUANTITY : 1 UNIT

MANUFACTURER : FAVELLE FAVCO CRANES

**THE ABOVE CRANE WAS DESIGNED AND MANUFACTURED BY
FAVELLE FAVCO CRANES IN 2016 TO CONFORM TO AUSTRALIAN
STANDARD AS1418, PARTS 1 & 4.**

Signed :

WONG CHIN WAI
QA/QC MANAGER

Date : **7/4/2016**

For and on behalf of : FAVELLE FAVCO CRANES (M) SDN. BHD.





3125-17#
LOT 42, PERSIARAN BUNGA TANJUNG 2,
SENAWANG INDUSTRIAL PARK,
70400 SEREMBAN,
NEGERI SEMBILAN DARUL KHUSUS, MALAYSIA.
TEL : (606) 6768866
FAX : (606) 6768888
E-MAIL : admin@favellefavco.com.my

Ref No : FFCM/2230/2016

Project	Crane Model	Crane Serial No	Date
TOWER CRANE	M440D	2230	7-Apr-16

CERTIFICATE OF QUANTITY & QUALITY

CUSTOMER : FAVCO INTERNATIONAL SHANGHAI
COUNTRY OF ORIGIN : MALAYSIA
GOODS DESCRIPTION : TOWER CRANE
MANUFACTURER : FAVELLE FAVCO CRANES (M) SDN BHD
YEAR OF MANUFACTURE : 2016

WE CERTIFIED THAT THE COMPONENT WERE DESIGNED AND MANUFACTURED ON THE DATE STATED AND CONFIRMED ALL THE REQUIREMENT OF THE CONTRACT or PURCHASE ORDER.
CRANE STRUCTURE WERE DESIGNED TO AS 1418 PART 1 & 4
THE COMPONENT LISTED BELOW HAD BEEN INSPECTED SATISFACTORY AND DELIVERED TO ABOVE ADDRESS.

QUANTITY /WEIGHT OF SHIPPED GOODS :

PACKAGE	QTY	DESCRIPTION	GROSS WT (T)
1	1	MACHINERY DECK ASSEMBLY (INCLUDING SLEW RING & DRIVES)	16.7
2	1	MAST ASSEMBLY	6.3
3	1	CABIN ASSEMBLY	1
4	1	MAIN & LUFF WINCH (INCLUDING ROPES)	16.7
5	1	BOOM ASSEMBLY	11.7
6	1	COUNTERWEIGHT ASSEMBLY	40
7	1	SLEW MOUNT ASSEMBLY	5.8
8	1	BRIDLE ASSEMBLY	0.6
9	1	MAIN HOOK ASSEMBLY	1.4
10	1	PENDANT ROPE ASSEMBLY	1.5

SIGNATURE

For and on behalf of FAVELLE FAVCO CRANES (M) SDN. BHD

Date : 7-Apr-16

备案证书或IC卡:

上海市建筑起重机械产权备案登记证

设备信息栏

编号：沪-T-15520

设备名称：塔式起重机

产权单位：上海市机械施工集团有限公司

型号规格：M440D

单位地址：上海市嘉定区顺达路615号

制造单位：Favelle Favco Cranes (M)SDN BHD

出厂编号：2230

登记机关：上海市建设安全协会
上海市建筑起重机械
产权备案登记专用章
2016年12月23日

出厂日期：2016年04月07日

特种设备生产许可证编号：
2C-0020

登记证编号：T004996